

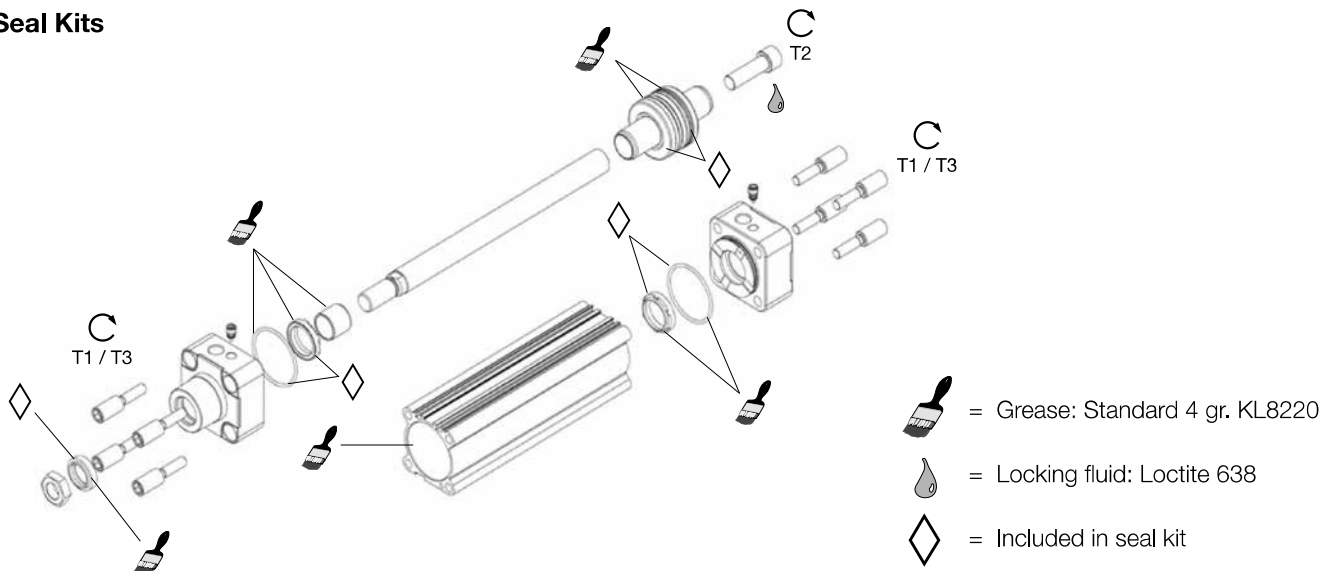



AZ Cylinders

Only for cylinders with item numbers beginning PA
e.g. PA61240-0125



Seal Kits











-  = Grease: Standard 4 gr. KL8220
-  = Locking fluid: Loctite 638
-  = Included in seal kit

Seal kit order codes

Cyl. Ø	AZ5000 / AZD5000 / AZZ6000 Standard	AZ1000 Viton	AZ...A with metal scraper	AZ...D with through rod	AZ...H hydraulic version
32	PD39169	PD39499	PD41012	PD39381	PD39505
40	PD39170	PD39500	PD41013	PD39382	PD39506
50	PD39171	PD39501	PD41014	PD39383	PD39507
63	PD39172	PD39502	PD41015	PD39384	PD39508
80	PD39173	PD39503	PD41016	PD39385	PD39509
100	PD39174	PD39504	PD41017	PD39386	PD39510

ISO Cylinder

Cyl. Ø	T1 		T2 		T3 	
32	10 - 12 Nm	6	5 - 6 Nm	5	4 - 5 Nm	6
40	10 - 12 Nm	6	12 - 14 Nm	6	4 - 5 Nm	6
50	16 - 20 Nm	8	16 - 18 Nm	10	9 - 10 Nm	8
63	16 - 20 Nm	8	16 - 18 Nm	10	9 - 10 Nm	8
80	26 - 32 Nm	10	20 - 23 Nm	12	18 - 20 Nm	10
100	26 - 32 Nm	10	20 - 23 Nm	12	18 - 20 Nm	10

- T3  = torque tie rod cylinder
-  = across flats tie rod cylinder