

HF HeadlineFilters

Part Number: DIF-BN70

Technical Specification	
Description	Disposable In-line Filter
Materials of Construction	Nylon with Borosilicate Glass filter element bonded with fluorocarbon
Filtration Efficiency	Better than 95.00+% removal of 0.1 micron particles
Max Pressure Drop	1 Bar
Dimensions	O.D. - 25.40 ± 1.5mm Length - 82.25 ± 0.25mm
Flow Rate-	Air flow Nm ³ /hr at 0.1 Bar pressure drop 0.1Bar 1Bar 2Bar 4Bar 7Bar 10Bar 1.8 3.6 5.0 9.0 14 18
Max Temperature	At 0 Bar pressure 110°C
Max Pressure	At 40°C 7 Bar

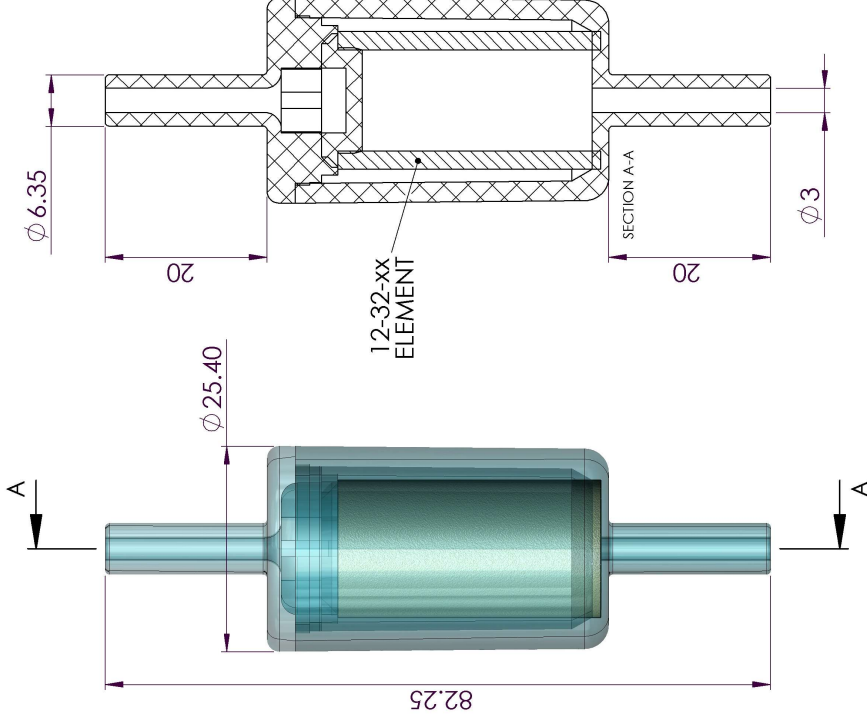

For further specific information please contact our Technical Department
This is a guide only

Headline Filters Limited Mill Hall Business Estate
Aylesford
Kent, ME20 7JZ
www.headlinefilters.com
info@headlinefilters.com

**DO NOT SCALE DRAWING
IF IN DOUBT ASK**

Part Number: DIF-BN70

Material:
Nylon with Borosilicate
Glass filter element
bonded with
fluorocarbon

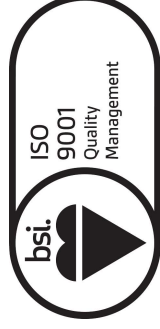

THE COPYRIGHT OF THIS DRAWING IS RESERVED BY HEADLINE FILTERS. IT IS ISSUED ON CONDITION THAT IT IS NOT COPIED, REPRODUCED OR DISCLOSED TO A THIRD PARTY EITHER WHOLLY, OR IN PART WITHOUT CONSENT IN WRITING.