

Ball Valves, Mini Series

With their **push-in connections**, these polymer lightweight ball valves allow for a significant reduction in installation time while offering **full flow capability** and **compact dimensions**.

Product Advantages

Optimum Solution

- Full flow
- Marked with the pneumatic symbol for identification of its function
- Lightweight and compact
- Extremely compact, easy-to-operate lever
- Lever with screwdriver slot to facilitate operation
- Designed for polymer tubing with no tube preparation
- Can be mounted on a wall or adjacent using staples



Proven Technology

- LF 3000® push-in connection, excellent static and dynamic sealing
- High-strength polyamide
- Excellent long-term performance
- Automatic seal wear compensation for long-term reliability
- 100% leak-tested in production
- Date coding to guarantee quality and traceability

Applications

- Robotics
- Vacuum
- Semi-Conductors
- Packaging
- Textile
- Pneumatics

Technical Characteristics

Compatible Fluids	Compressed air			
Working Pressure	Vacuum to 10 bar			
Working Temperature	-20°C to +80°C			

Tightening Torques	Threads	G1/8	G1/4	G3/8	G1/2
	daN.m	0.8	1.2	3	3.5

Reliable performance is dependent upon the type of fluid conveyed, component materials and tubing being used.
Guaranteed for use with a vacuum of 755 mm Hg (99 % vacuum).

Component Materials

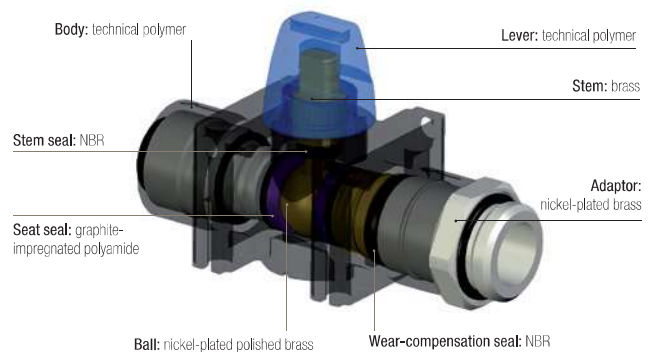

Silicone-free

Operation

Vented Valve, Open Position

3/2 model with vent

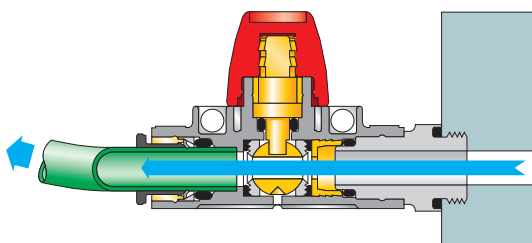

Vented Valve, Closed Position

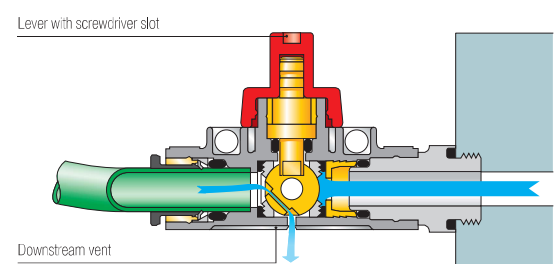

Mini Series

7910 2/2 In-Line Mini-Ball Valve

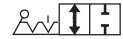

Technical polymer, NBR

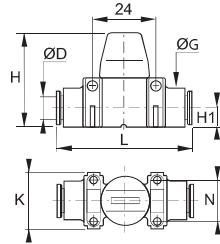

ØD		G	H	H1	K	L	N	kg
4	7910 04 00	15	37	7.5	22	51	16	0.039
6	7910 06 00	15	37	7.5	22	52	16	0.034
8	7910 08 00	15	37	7.5	22	52	16	0.025
10	7910 10 00	20	43	11	30	66	22	0.060
12	7910 12 00	20	43	11	30	66	22	0.040

7911 2/2 In-Line Mini-Ball Valve, Male BSPP Thread

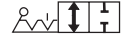

Technical polymer, nickel-plated brass, NBR

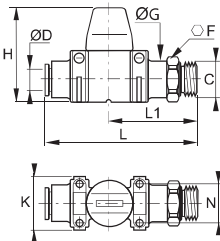

ØD	C		F	G	H	K	L	L1	N	kg
6	G1/8	7911 06 10	13	14	37	22	62	37	16	0.045
8	G1/4	7911 08 13	16	17.5	37	22	61	35	16	0.040
10	G3/8	7911 10 17	20	22	43	30	74	41	22	0.075
12	G1/2	7911 12 21	24	26	43	30	75	42	22	0.075

7913 3/2 In-Line Mini-Ball Valve with Vent



Technical polymer, NBR

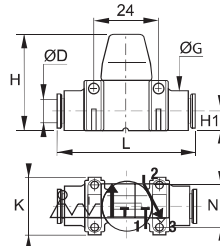

ØD		G	H	H1	K	L	N	kg
4	7913 04 00	15	37	7.5	22	51	16	0.040
6	7913 06 00	15	37	7.5	22	52	16	0.035
8	7913 08 00	15	37	7.5	22	52	16	0.025
10	7913 10 00	20	43	11	30	66	22	0.060
12	7913 12 00	20	43	11	30	66	22	0.045

7914 3/2 In-Line Mini-Ball Valve with Vent, Male BSPP Thread



Technical polymer, nickel-plated brass, NBR

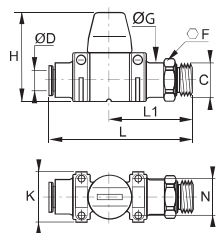

ØD	C		F	G	H	K	L	L1	N	kg
6	G1/8	7914 06 10	13	14	37	22	62	37	16	0.045
8	G1/4	7914 08 13	16	17.5	37	22	61	35	16	0.040
10	G3/8	7914 10 17	20	22	43	30	74	41	22	0.058
12	G1/2	7914 12 21	24	26	43	30	75	42	22	0.075

7000 Joining Clips

Technical polymer



ØD		kg
4	7000 00 05	0.004
6	7000 00 05	0.004
8	7000 00 05	0.004
10	7000 00 06	0.009
12	7000 00 06	0.009