

# Fluoropolymer Tubing Variations

## TL/TIL/TLM/TILM/TH/TH/TH/TID Series



### High Purity Fluoropolymer Tubing TL/TIL Series

**Material Super PFA**

It is suitable for applications which require a highly smooth internal surface and small amount of elution of fluorine ions.  
\* It has heat and chemical resistance equivalent to PFA. **P.502**

### Fluoropolymer Tubing (PFA) TLM/TILM Series

**Material PFA**

The material consists of a good chemical resistant fluoropolymer. This also has good heat resistance, and it is suitable for a wide range of applications. **P.503**

### FEP Tubing (Fluoropolymer) TH/TH Series

**Material FEP**

This has better resistance in chemical environments. **P.506**

### Soft Fluoropolymer Tubing TD/TID Series

**Material Modified PTFE**

**Flexibility improved by approx. 20%**  
(Compared with SMC TL/TIL Series)  
Suitable for applications which require flexibility. **P.509**

- KQ2
- KQG2
- KS  
KX
- KM
- KF
- M
- H/DL  
L/LL
- KC
- KK
- KK130
- DM
- KDM
- KB
- KR
- KA
- KQG2
- KG
- KFG2
- MS
- KKA
- KP
- LQ
- MQR
- T
- IDK

Series		TL/TIL	TLM/TILM	TH/TH	TD/TID
Material		Super PFA	PFA	FEP	Modified PTFE
Chemical resistance		◎	◎	○	◎
Heat resistance		260°C	260°C	200°C	260°C
Flexibility		△	△	△	○
Ion elution		◎	○	○	○
Internal smoothness		○	△	◎	○
Fluid		Chemicals, Deionized water	Chemicals, Deionized water	Air, Water, Inert gas	
Tubing O.D.	Metric	ø4 to ø19	ø2 to ø25	ø4 to ø12	ø4 to ø12
	Inch	1/8" to 1"	1/8" to 1 1/4"	1/8" to 3/4"	1/8" to 1/2"
Color		Translucent	Translucent, Red, Blue, Black	Translucent, Red, Blue, Black	Translucent
Applicable fitting series	One-touch fittings	—	KQ2, KQG2, KP, KP□	KQ2, KQG2, KP, KP□	—
	Miniature fittings	—	M, MS (Hose nipple type)	M, MS (Hose nipple type)	M, MS (Hose nipple type)
	Insert fittings	—	KF, KFG2	KF, KFG2	KF, KFG2
	Fluoropolymer fittings	LQ series	LQ series	LQ series	LQ series

◎: Very good ○: Good △: Moderate  
The comparison table shown above was prepared based on a relative comparison taking the characteristics of each fluoropolymer tubing into consideration.



# High Purity Fluoropolymer Tubing TL/TIL Series

Material: Super PFA

## Series and Specifications

		Metric sizes (TL series)						Inch sizes (TIL series)							
Tubing model		TL0403	TL0604	TL0806	TL1008	TL1210	TL1916	TIL01	TILB01	TIL05	TIL07	TIL11	TIL13	TIL19	TIL25
Nominal diameter		—	—	—	—	—	—	1/8"	1/8"	3/16"	1/4"	3/8"	1/2"	3/4"	1"
Tubing size		ø4 x ø3	ø6 x ø4	ø8 x ø6	ø10 x ø8	ø12 x ø10	ø19 x ø16	1/8" x 0.086"	1/8" x 1/16"	3/16" x 1/8"	1/4" x 5/32"	3/8" x 1/4"	1/2" x 3/8"	3/4" x 5/8"	1" x 7/8"
O.D. (mm)	Basic diameter	4	6	8	10	12	19	3.18	3.18	4.75	6.35	9.53	12.7	19.05	25.4
	Tolerance	±0.1			+0.2 -0.1			±0.1			+0.2 -0.1				
Thickness (mm)	Basic diameter	0.5		1			1.5	0.5	0.8	0.8	1.2	1.6			
	Tolerance	±0.05		±0.1			±0.15	±0.05	±0.08	±0.08	±0.12	±0.15			
Bundle	10 m	—	—	—	●	●	●	—	—	—	—	●	●	—	—
	20 m	●	●	●	●	●	●	●	—	●	●	●	●	●	●
	50 m	●	●	●	●	●	●	●	—	●	●	●	●	●	●
	100 m	●	●	●	●	●	●	●	—	●	●	●	●	●	—
	16 m (50 ft)	—	—	—	—	—	—	●	●	●	●	●	●	●	●
	33 m (100 ft)	—	—	—	—	—	—	●	●	●	●	●	●	●	●
Straight pipe		●	●	●	●	●	●	●	—	●	●	●	●	●	●
Color		Translucent (color of material)													
Applicable fluid		Refer to the applicable fluid in page 511.													
Applicable fittings		Fluoropolymer Fittings LQ series													
Max. operating pressure (MPa)	20°C	1.0	1.0	1.0	0.9	0.7	0.6	1.0	1.0	1.0	1.0	1.0	1.0	0.7	0.5
	100°C	0.45	0.64	0.43	0.33	0.27	0.24	0.59	0.92	0.62	0.73	0.62	0.43	0.26	0.19
	200°C	0.21	0.29	0.20	0.15	0.12	0.11	0.27	0.42	0.28	0.34	0.28	0.20	0.12	0.09
	260°C	0.09	0.12	0.08	0.06	0.05	0.05	0.11	0.17	0.12	0.14	0.12	0.08	0.05	0.04
Burst pressure (MPa at 20°C)		4.9	6.9	4.7	3.6	2.9	2.6	6.4	9.9	6.7	7.9	6.7	4.6	2.8	2.0
Min. bending radius (mm)	Recommended radius	35	35	60	100	130	220	20	10	25	35	60	95	220	400
	Tube close bend radius	20	20	40	65	110	160	12	6	20	20	30	60	160	290
Max. operating temperature (Fixed use)		260°C													
Material		Super PFA													

Note 1) When using the product at a temperature other than those shown in the table above, use it at a maximum operating pressure or less that is calculated from the following formula.  
 (Max. operating pressure) = 1/4 x (burst pressure drop coefficient) x (burst pressure at 20°C)  
 Note 2) When using a fluid in liquid form, the surge pressure must be no more than the maximum operating pressure. A surge pressure higher than the maximum operating pressure can cause breakage of the fitting or bursting of the tubing. Furthermore, abnormal temperature rise caused by adiabatic compression may result in the tube bursting.  
 Note 3) Do not use this product in a manner in which the tube is not fixed. Observe the lesser value of the maximum operating pressure between the tubing and fitting. A material change over a long duration or due to high-temperature may cause leakage. Perform periodic maintenance and replace with a new product immediately when abnormalities are detected. (Refer to "Maintenance" of the tubing precautions on page 514.)  
 For other precautions, refer to "Fittings & Tubing Precautions" on pages 13 to 17. When using the fluoropolymer fittings, refer to the precautions on pages 445 and 446.  
 Note 4) Minimum bending radius is measured as shown left as representative values. • Use a tube above the recommended minimum bending radius. • The tube may be bent if used under the recommended minimum bending radius. Therefore, refer to the tube close bend radius and make sure that the tube is not bent or flattened. • Please note that the tube close bend radius is not warranted because of the value when 2R is measured by the method in the right figure if the tube is bent or flattened, etc. • The minimum bending radius shown above does not apply to the straight pipe (2 m).  
 Note 5) As for other commercial items, there are some cases it is not able to connect due to tolerance of dimensions.

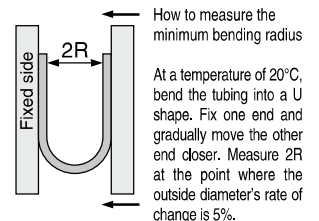

## Burst pressure drop curve

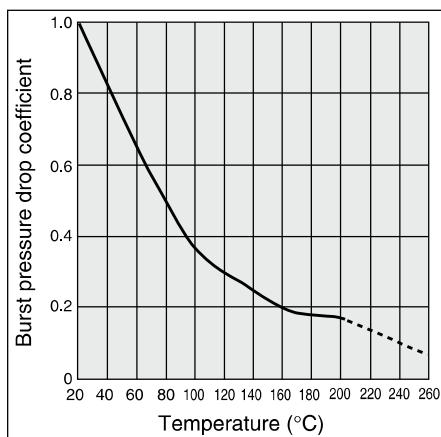

## How to Order

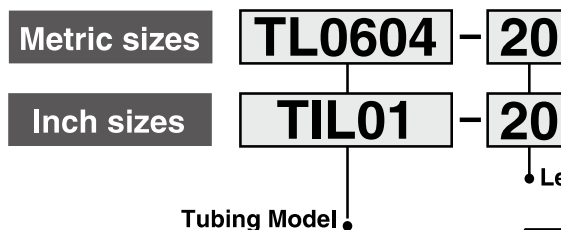

Length Applicable to both metric and inch size

Symbol	Type	Length
10	Roll	10 m
20		20 m
50		50 m
100		100 m
2S	Straight	2 m

## Eluting fluorine ion amount <sup>Note 6)</sup> (µg/g)

Type	Fluorine ion
Eluting amount	0.1 or less

A 15 g piece of fluororesin tubing is cut off, washed in DI water (puer water) and immersed in 15 mL of 25% methyl alcohol extract at room temperature for 24 hours. Then the extract is diluted with DI water (puer water) to be subjected to a quantitative analysis of fluorine ions.

## Eluting metal ion amount <sup>Note 6)</sup> (ng/cm<sup>2</sup>)

Type	Al	Fe	Ni	Na	Ca
Eluting amount	4.5	0.3	0.2	7.1	1.3

The interior of the fluororesin tubing is washed with super deionized water. Approximately 20 g of super high purity hydrofluoric acid (48%) is measured and injected into the tubing. The interior wall of the tubing is immersed at normal temperature for one week with both ends of the tubing plugged. Then the extract was diluted with super deionized water to be subjected to a quantitative analysis on Al, Fe, Ni, Na and Ca by the stripping method.

## Length Applicable to inch size only

Symbol	Type	Length
16	Roll	16 m (50 ft)
33		33 m (100 ft)

Please refer to the "Series and Specifications" above, as the tubing length differs depending on each size.

Note 6) Figures shown in tables are representative values, not guaranteed values.

# Fluoropolymer Tubing **PFA**

## TLM/TILM Series

RoHS

# Max. operating temperature: 260°C

### 22 size variations

**Metric size**  $\varnothing 2$  to  $\varnothing 25$  (13 sizes)

**Inch size** 1/8" to 1 1/4" (9 sizes)

**Length per roll** 10 m, 20 m, 50 m, 100 m

**Length per roll** 10 m, 20 m, 50 m, 100 m  
16 m (50 ft), 33 m (100 ft)

**Straight** 2 m

**Straight** 2 m

### 4 color variations

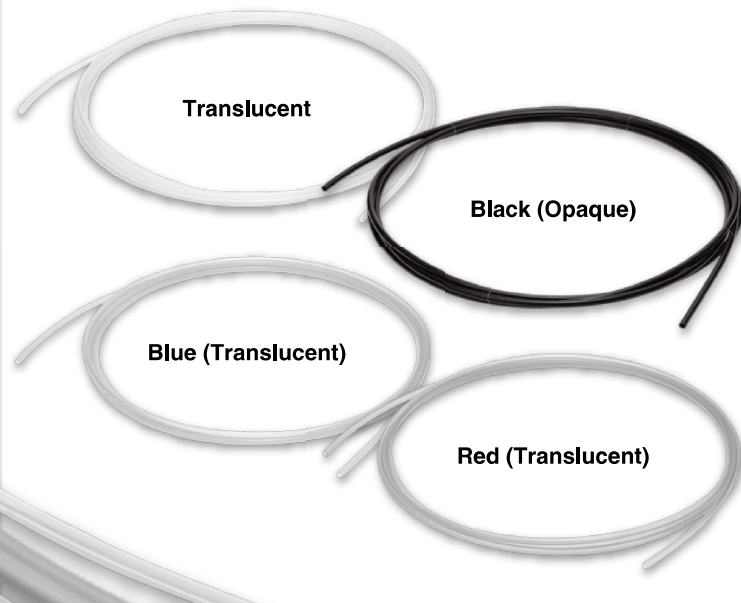

### Applications

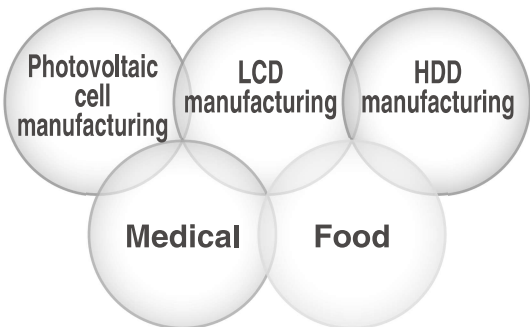

### Compatible with Food Sanitation Law

- Compatible with the test conforming to Japan's Food Sanitation Law based on the 370th notice given by the Ministry of Health and Welfare in 1959.
- Complies with FDA (Food and Drug Administration) §177-1550 dissolution test.

KQ2

KQB2

KS  
KX

KM

KF

MI

H/DL  
L/LL

KC

KK

KK130

DM

KDM

KB

KR

KA

KQG2

KG

KFG2

MS

KKA

KP

LQ

MQR

T

IDK

# Fluoropolymer Tubing (PFA) Metric Size **TLM Series**



## Series

Size			Metric size													
Model			TLM0201	TLM0302	TLM0425	TLM0403	TLM0604	TLM0806	TLM1075	TLM1008	TLM1209	TLM1210	TLM1613	TLM1916	TLM2522	
Tubing size			ø2 x ø1	ø3 x ø2	ø4 x ø2.5	ø4 x ø3	ø6 x ø4	ø8 x ø6	ø10 x ø7.5	ø10 x ø8	ø12 x ø9	ø12 x ø10	ø16 x ø13	ø19 x ø16	ø25 x ø22	
O.D. (mm)			2	3	4	4	6	8	10	10	12	12	16	19	25	
I.D. (mm)			1	2	2.5	3	4	6	7.5	8	9	10	13	16	22	
Length per roll	Color	Symbol														
Roll	10 m	Translucent	N													
	20 m	Translucent	N	●	●	●	●	●	●	●	●	●	●	●	●	●
		Red (Translucent)	R	●	●	●	●	●	●	●	●	●	●	●	●	●
		Blue (Translucent)	BU	●	●	●	●	●	●	●	●	●	●	●	●	●
		Black (Opaque)	B	●	●	●	●	●	●	●	●	●	●	●	●	●
	50 m	Translucent	N	●	●	●	●	●	●	●	●	●	●	●	●	●
100 m	Translucent	N	●	●	●	●	●	●	●	●	●	●	●	●	●	
Straight	2 m	Translucent	N	●	●	●	●	●	●	●	●	●	●	●	●	

Inch O.D. size  
5/32"

Inch O.D. size  
5/16"

O.D. 3.2 mm is available in ø 1/8 inch (3.18 mm) tubing.  
For details, refer to the table "Series" on page 505.

## Specifications

<b>Fluid</b> <sup>Note 1) 2) 3)</sup> and applicable fittings <sup>Note 1) 2) 3)</sup>	Fluid: Refer to "Applicable Fluid List" on page 512. Fittings: Fluoropolymer fittings LQ series														
	Fluid: Air, Water, Inert gas Fittings: One-touch fittings KQ2, KQG2, Clean One-touch fittings KP, KP□ Insert fittings KF, KFG2, Miniature fittings M, MS (Hose nipple type)														
<b>Max. operating pressure (MPa)</b>	Refer to the max. operating pressure curve.														
<b>Min. bending radius (mm)</b> <sup>Note 4)</sup>	Recommended radius	10	20	20	35	35	60	95	100	100	130	160	220	400	
	Tube close bend radius	7	15	15	20	20	40	60	65	65	110	130	160	290	
<b>Max. operating temperature</b>	260°C														
<b>Material</b>	PFA (Tetrafluoroethylene perfluoroalkoxy vinyl ether copolymer)														

Note 1) Fluid varies depending on the applicable fittings.

Note 2) When using a liquid fluid, the surge pressure must not exceed the maximum operating pressure. If the surge pressure exceeds the maximum operating pressure, it will result in damage to fittings and tubes. Furthermore, abnormal temperature rise caused by adiabatic compression may result in the tube bursting.

Note 3) Do not use this product in a manner in which the tube is not fixed. Observe the lesser value of the maximum operating pressure between the tubing and fitting. A material change over a long duration or due to high-temperature may cause leakage. Perform periodic maintenance and replace with a new product immediately when abnormalities are detected. (Refer to "Maintenance" of the tubing precautions on page 514.)

For other precautions, refer to "Fittings & Tubing Precautions" on pages 13 to 17. When using the fluoropolymer fittings, refer to the precautions on pages 445 and 446.

Note 4) Minimum bending radius is measured as shown left as representative values.

- Use a tube above the recommended minimum bending radius.
- The tube may be bent if used under the recommended minimum bending radius. Therefore, refer to the tube close bend radius and make sure that the tube is not bent or flattened.
- Please note that the tube close bend radius is not warranted because of the value when 2R is measured by the method in the right figure if the tube is bent or flattened, etc.
- The minimum bending radius shown above does not apply to the straight pipe (2 m).

### How to measure the minimum bending radius

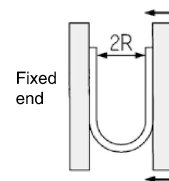

At a temperature of 20°C, bend the tubing into a U shape. Fix one end and gradually move the other end closer. Measure 2R at the point where the outside diameter's rate of change is 5%.

## Max. Operating Pressure

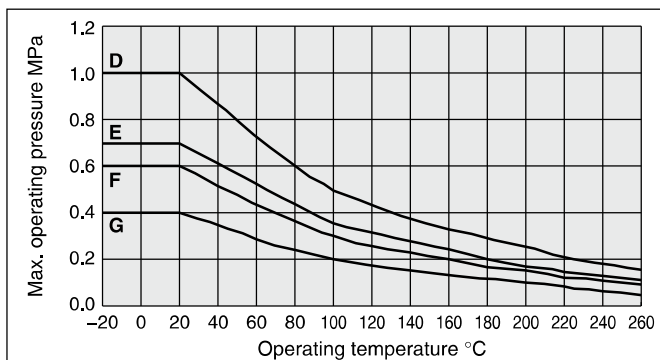
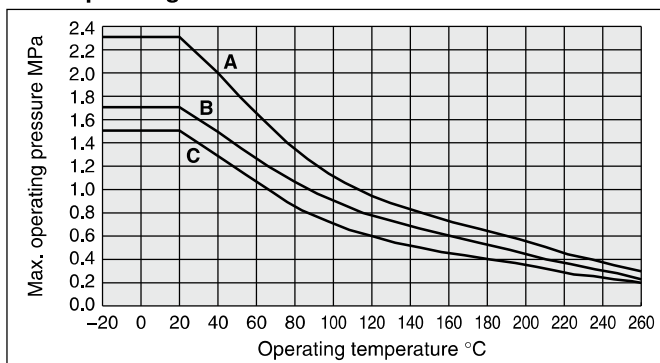

Group	Model	Max. operating pressure (MPa)			
		20°C	100°C	200°C	260°C
A	TLM0201	2.3	1.1	0.55	0.3
B	TLM0425	1.7	0.9	0.45	0.23
C	TLM0302	1.5	0.7	0.35	0.2
	TLM0604				
D	TLM0403	1	0.5	0.25	0.15
	TLM0806				
	TLM1075				
E	TLM1209	0.7	0.35	0.17	0.11
	TLM1008				
F	TLM1613	0.6	0.3	0.15	0.1
	TLM1210				
G	TLM1916	0.4	0.2	0.1	0.05
	TLM2522				

## How to Order

### Metric size

**TLM0425 N - 20**

Tubing designation

### Color indication

Symbol	Color
N	Translucent (Material color)
R	Red (Translucent)
BU	Blue (Translucent)
B	Black (Opaque)

### Length per roll

Symbol	Type	Length
10	Roll	10 m
20		20 m
50		50 m
100		100 m
2S	Straight	2 m

Note) Refer to the table "Series" above, as the tubing length differs depending on each size.

# Fluoropolymer Tubing (PFA)

## Inch Size

# TILM Series



### Series

Size Model			Inch size								
Tubing size			TILM01	TILMB01	TILM05	TILM07	TILM11	TILM13	TILM19	TILM25	TILM32
O.D.	inch		1/8" x 0.086"	1/8" x 1/16"	3/16" x 1/8"	1/4" x 5/32"	3/8" x 1/4"	1/2" x 3/8"	3/4" x 5/8"	1" x 7/8"	1 1/4" x 1 1/10"
	mm		3.18	1.91	4.75	6.35	9.53	12.7	19.05	25.4	31.75
I.D.	inch		0.086"	1/16"	1/8"	5/32"	1/4"	3/8"	5/8"	7/8"	1 1/10"
	mm		2.18	1.58	3.15	3.95	6.33	9.5	15.85	22.2	27.95

Length per roll	Color	Symbol	TILM01	TILMB01	TILM05	TILM07	TILM11	TILM13	TILM19	TILM25	TILM32
Roll	10 m	Translucent	N	●	●	●	●	●	●	●	●
		Red (Translucent)	R	●	●	●	●	●	●	●	●
	20 m	Blue (Translucent)	BU	●	●	●	●	●	●	●	●
		Black (Opaque)	B	●	●	●	●	●	●	●	●
	50 m	Translucent	N	●	●	●	●	●	●	●	●
		Translucent	N	●	●	●	●	●	●	●	●
	16 m (50 ft)	Translucent	N	●	●	●	●	●	●	●	●
	33 m (100 ft)	Translucent	N	●	●	●	●	●	●	●	●
Straight	2 m	Translucent	N	●	●	●	●	●	●	●	

Metric O.D. size	3.2
------------------	-----

O.D. 5/32" is available in ø4 metric tubing, and O.D. 5/16" is available in ø8 metric tubing. For details, refer to the table "Series" on page 504.

### Specifications

<b>Fluid</b> (Note 1) 2) 3) and <b>applicable fittings</b> (Note 1) 2) 3)	Fluid: Refer to "Applicable Fluid List" on page 512. Fittings: Fluoropolymer fittings LQ series									
<b>Max. operating pressure (MPa)</b>	Fluid: Air, Water, Inert gas Fittings: One-touch fittings KQ2, KQG2, Insert fittings KFG2									
<b>Min. bending radius (mm)</b> (Note 4)	Recommended radius	20	10	25	35	60	95	220	400	500
	Tube close bend radius	12	6	20	20	30	60	160	290	360
<b>Max. operating temperature</b>	260°C									
<b>Material</b>	PFA (Tetrafluoroethylene perfluoroalkoxy vinyl ether copolymer)									

- Note 1) Fluid varies depending on the applicable fittings.  
 Note 2) When using a liquid fluid, the surge pressure must not exceed the maximum operating pressure. If the surge pressure exceeds the maximum operating pressure, it will result in damage to fittings and tubes. Furthermore, abnormal temperature rise caused by adiabatic compression may result in the tube bursting.  
 Note 3) Do not use this product in a manner in which the tube is not fixed. Observe the lesser value of the maximum operating pressure between the tube and fitting. A material change over a long duration or due to high-temperature may cause leakage. Perform periodic maintenance and replace with a new product immediately when abnormalities are detected. (Refer to "Maintenance" of the tubing precautions on page 514.) For other precautions, refer to "Fittings & Tubing Precautions" on pages 13 to 17. When using the fluoropolymer fittings, refer to the precautions on pages 445 and 446.  
 Note 4) Minimum bending radius is measured as shown left as representative values.
- Use a tube above the recommended minimum bending radius.
  - The tube may be bent if used under the recommended minimum bending radius. Therefore, refer to the tube close bend radius and make sure that the tube is not bent or flattened.
  - Please note that the tube close bend radius is not warranted because of the value when 2R is measured by the method in the right figure if the tube is bent or flattened, etc.
  - The minimum bending radius shown above does not apply to the straight pipe (2 m).

#### How to measure the minimum bending radius

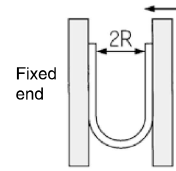

At a temperature of 20°C, bend the tubing into a U shape. Fix one end and gradually move the other end closer. Measure 2R at the point where the outside diameter's rate of change is 5%.

### Max. Operating Pressure

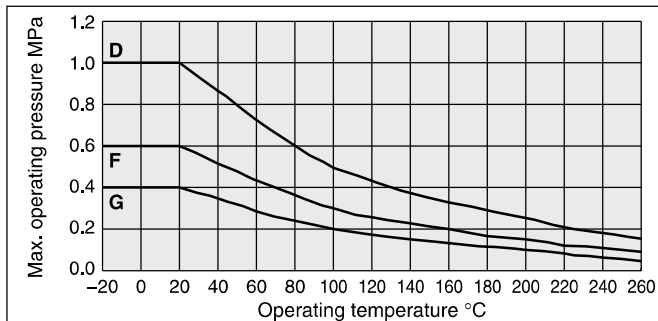
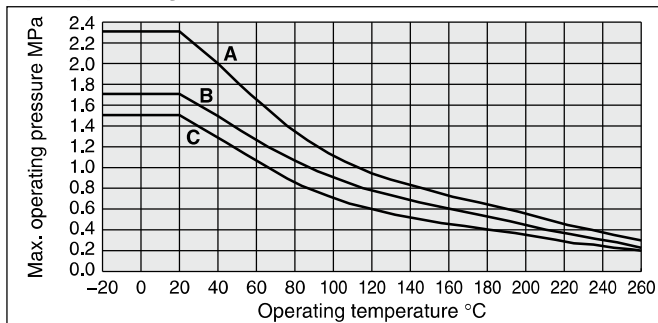

Group	Model	Max. operating pressure (MPa)			
		20°C	100°C	200°C	260°C
A	TILMB01	2.3	1.1	0.55	0.3
B	TILM07	1.7	0.9	0.45	0.23
C	TILM05 TILM11	1.5	0.7	0.35	0.2
D	TILM01 TILM13	1.0	0.5	0.25	0.15
F	TILM19	0.6	0.3	0.15	0.1
G	TILM25 TILM32	0.4	0.2	0.1	0.05

### How to Order

#### Inch size

**TILM01 N - 20**

Tubing designation

Color indication	
Symbol	Color
N	Translucent (Material color)
R	Red (Translucent)
BU	Blue (Translucent)
B	Black (Opaque)

Length per roll

Symbol	Type	Length
10	Roll	10 m
20		20 m
50		50 m
100		100 m
16		16 m (50 ft)
33	33 m (100 ft)	
2S	Straight	2 m

Note) Refer to the table "Series" above, as the tubing length differs depending on each size.

KQ2

KQB2

KS  
KX

KM

KF

M

H/DL  
L/LL

KC

KK

KK130

DM

KDM

KB

KR

KA

KQG2

KG

KFG2

MS

KKA

KP

LQ

MQR

T

IDK

# FEP Tubing (Fluoropolymer) Metric Size TH Series

RoHS



**Operating Temperature: Max. 200°C**  
It varies depending on the operating pressure. Refer to the graph for the maximum operating pressure.

### Compatible with the Food Sanitation Law

- Compatible with the test conforming to the Food Sanitation Law based on the 370th notice given by the Ministry of Health and Welfare in 1959.
- Complies with FDA (Food and Drug Administration) §177-1550 dissolution test.

**How to measure the minimum bending radius.**

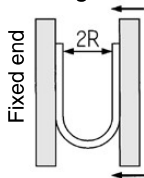

At a temperature of 20°C, bend the tubing into a U shape. Fix one end and gradually move the other end closer. Measure 2R at the point where the outside diameter's rate of change is 5%.

### Max. Operating Pressure

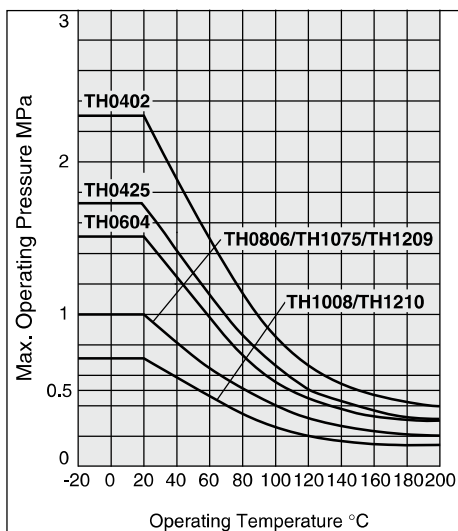

Note) The maximum operating pressure varies dependant on the I.D. bore size even if the O.D. is the same.

### Series

●-20 m roll □-100 m roll

Model	Metric size							
	TH0402	TH0425	TH0604	TH0806	TH1075	TH1008	TH1209	TH1210
Tubing O.D. (mm)	4	4	6	8	10	10	12	12
Tubing I.D. (mm)	2	2.5	4	6	7.5	8	9	10

Color	Symbol	Inch nominal size							
Translucent	N	5/32"	5/32"	5/32"	5/16"	5/16"	5/16"	5/16"	5/16"
Red (Translucent)	R	●	●	●	●	●	●	●	●
Blue (Translucent)	BU	●	●	●	●	●	●	●	●
Black (Opaque)	B	●	●	●	●	●	●	●	●

### Specifications

Fluid	Air, Water <sup>Note 1)</sup> , Inert gas							
Applicable fittings <sup>Note 2)</sup>	One-touch fittings, Insert fittings Fluoropolymer fittings: LQ series <sup>Note 3)</sup> Miniature fittings: M, MS series (Hose nipple type)							
Max. operating pressure (MPa)	20°C	2.3	1.7	1.5	1	0.7	1	0.7
	100°C	0.85	0.6	0.55	0.4	0.25	0.4	0.25
	200°C	0.4	0.3	0.3	0.2	0.1	0.2	0.1
Refer to the max. operating pressure curve.								
Min. bending radius (mm) <sup>Note 4)</sup>	Recommended radius	15	20	35	60	95	100	130
	Tube close bend radius	10	15	20	40	60	65	110
Operating temperature	Air, Inert gas: -20 to 200°C Water: 0 to 100°C (No freezing)							
Material	FEP (Fluorinated Ethylene Propylene Resin)							

Note 1) When using a fluid in liquid form, the surge pressure must not exceed the maximum operating pressure. A surge pressure higher than the maximum operating pressure can cause breakage of the fittings, or rupture of the tubing. Furthermore, an abnormal temperature increase due to adiabatic compression can also result in ruptured tubing.

Note 2) Do not use in locations where the FEP tubing will move.

Be sure to operate under the maximum operating pressure conditions using the lower maximum operating specification of either the tubing or fittings.

After long term use or under high temperatures, some fittings leakage may occur due to material deterioration with age. Perform periodic inspections, and if any leakage is detected, replace with a new product immediately.

When the insert and miniature fittings are used over extended periods of time, it may cause leakage due to the material deterioration of age. In such a case, give an additional tightening to the tube connection part. If leakage still occurs after giving an additional tightening, replace the fitting with a new product. For other precautions, refer to "Fittings & Tubing Precautions". When using the fluoropolymer fittings, refer to the precautions on pages 445 and 446. Select the size after confirming O.D. and I.D.

Note 3) TH0402, TH0425, TH1075 and TH1209 are not available because of different internal diameters.

Note 4) The minimum bending radius is the representative value measured as shown in the left figure.

- Use a tube above the recommended minimum bending radius.
- The tubing may be bent if used under the recommended minimum bending radius. Therefore, refer to the tube close bend radius and make sure that the tubing is not bent or flattened.
- Please note that the tube close bend radius is not warranted because of the value when 2R is measured by the method in the left figure if the tubing is bent or flattened, etc.

### How to Order

Metric size

**TH0604 N - 20**

Indication of tubing model

Color indication

Length per roll

Symbol	Color
N	Translucent (Material color)
R	Red (Translucent)
BU	Blue (Translucent)
B	Black (Opaque)

Symbol	Roll size
20	20 m roll
100 <sup>Note)</sup>	100 m roll

Note) 100 m roll is available with translucent (color indication: N) only.

**Made to Order**

(Please contact SMC for specifications in detail, dimensions, delivery and specifications other than those mentioned above.)

Reinforced corrugated cardboard specification longer length reel

ø6, Translucent only: Suffix "-X64" to the end of part number. Ex.) TH0604N-500-X64

**Made to Order Availability**

Part no.	Length	Model	TH0604N	Color
X64	250 m reel		○	Translucent
	500 m reel		○	

**Reinforced corrugated cardboard specification: Longer length reel/-X64**

**Dimensions**

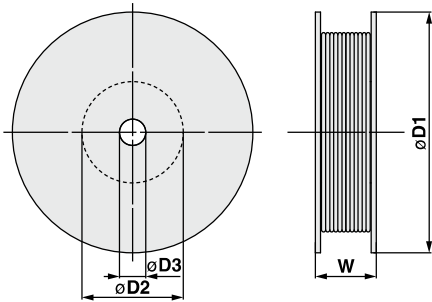

**Dimensions**

Model	øD1	øD2	øD3	W	Weight (kg)
TH0604N-250-X64	475	200	52	120	9.4
TH0604N-500-X64	475	200	52	220	18.5

KQ2

KQB2

KS  
KX

KM

KF

M

H/DL  
L/LL

KC

KK

KK130

DM

KDM

KB

KR

KA

KQG2

KG

KFG2

MS

KKA

KP

LQ

MQR

T

IDK

# FEP Tubing (Fluoropolymer)

## Inch Size

# TIH Series



### Operating Temperature: Max. 200°C

It varies depending on the operating pressure. Refer to the graph for the maximum operating pressure.

### Compatible with the Food Sanitation Law

- Compatible with the test conforming to the Food Sanitation Law based on the 370th notice given by the Ministry of Health and Welfare in 1959.
- Complies with FDA (Food and Drug Administration) §177-1550 dissolution test.

#### How to measure the minimum bending radius.

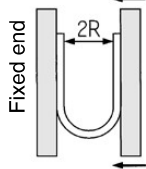

At a temperature of 20°C, bend the tubing into a U shape. Fix one end and gradually move the other end closer. Measure 2R at the point where the outside diameter's rate of change is 5%.

### Max. Operating Pressure

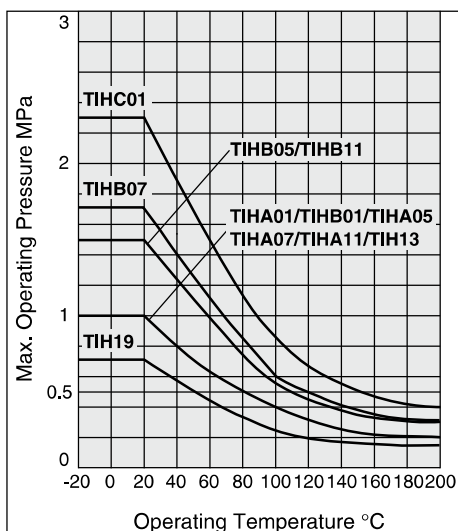

Note) The maximum operating pressure varies dependant on the I.D. bore size even if the O.D. is the same.

### Series

●-16 m (50 ft) roll □-33 m (100 ft) roll

Model		Inch size										
		TIHA01	TIHB01	TIHC01	TIHA05	TIHB05	TIHA07	TIHB07	TIHA11	TIHB11	TIH13	TIH19
Tubing O.D.	inch	1/8"			3/16"		1/4"		3/8"		1/2"	3/4"
	mm	3.18			4.75		6.35		9.53		12.7	19.05
Tubing I.D.	inch	0.093"	0.086"	0.065"	0.137"	0.124" (1/8")	0.18"	0.156" (5/32")	0.275"	0.25" (1/4")	0.374" (3/8")	0.624" (5/8")
	mm	2.36	2.18	1.65	3.48	3.15	4.57	3.95	6.99	6.33	9.5	15.85

Color	Symbol	TIHA01	TIHB01	TIHC01	TIHA05	TIHB05	TIHA07	TIHB07	TIHA11	TIHB11	TIH13	TIH19
Translucent	N	●	●	●	●	●	●	●	●	●	●	●
Red (Translucent)	R	●	●	●	●	●	●	●	●	●	●	●
Blue (Translucent)	BU	●	●	●	●	●	●	●	●	●	●	●
Black (Opaque)	B	●	●	●	●	●	●	●	●	●	●	●

### Specifications

Fluid	Air, Water <sup>Note 1)</sup> , Inert gas											
Applicable fittings <sup>Note 2)</sup>	One-touch fittings, Insert fittings, Fluoropolymer fittings: LQ series <sup>Note 3)</sup>											
Max. operating pressure (MPa)	20°C	1	2.3	1	1.5	1	1.7	1	1.5	1	0.7	
	100°C	0.4	0.85	0.4	0.55	0.4	0.6	0.4	0.55	0.4	0.25	
	200°C	0.2	0.4	0.2	0.3	0.2	0.3	0.2	0.3	0.2	0.1	
Refer to the max. operating pressure curve.												
Min. bending radius (mm) <sup>Note 4)</sup>	Recommended radius	25	20	10	35	25	55	35	85	60	95	220
	Tube close bend radius	20	12	7	25	20	35	20	55	30	60	160
Operating temperature	Air, Inert gas: -20 to 200°C Water: 0 to 100°C (No freezing)											
Material	FEP (Fluorinated Ethylene Propylene Resin)											

Note 1) When using a fluid in liquid form, the surge pressure must not exceed the maximum operating pressure. A surge pressure higher than the maximum operating pressure can cause breakage of the fittings, or rupture of the tubing. Furthermore, an abnormal temperature increase due to adiabatic compression can also result in ruptured tubing.

Note 2) Do not use in locations where the FEP tubing will move.

Be sure to operate under the maximum operating pressure conditions using the lower maximum operating specification of either the tubing or fittings.

After long term use or under high temperatures, some fittings leakage may occur due to material deterioration with age. Perform periodic inspections, and if any leakage is detected, replace with a new product immediately.

When the insert and miniature fittings are used over extended periods of time, it may cause leakage due to the material deterioration of age. In such a case, give an additional tightening to the tube connection part. If leakage still occurs after giving an additional tightening, replace the fitting with a new product. For other precautions, refer to "Fittings & Tubing Precautions". When using the fluoropolymer fittings, refer to the precautions on pages 445 and 446. Select the size after confirming O.D. and I.D.

Note 3) TIHA01, TIHC01, TIHA05, TIHA07 and TIHA11 are not available because of different internal diameters.

Note 4) The minimum bending radius is the representative value measured as shown in the left figure.

- Use a tube above the recommended minimum bending radius.
- The tubing may be bent if used under the recommended minimum bending radius. Therefore, refer to the tube close bend radius and make sure that the tubing is not bent or flattened.
- Please note that the tube close bend radius is not warranted because of the value when 2R is measured by the method in the left figure if the tubing is bent or flattened, etc.

### How to Order

Inch size

**TIHA01 N - 16**

Indication of tubing model

Color indication

Symbol	Color
N	Translucent (Material color)
R	Red (Translucent)
BU	Blue (Translucent)
B	Black (Opaque)

Length per roll

Symbol	Roll size
16	16 m (50 ft) roll
33 <sup>Note)</sup>	33 m (100 ft) roll

Note) 33 m (100 ft) roll is available with translucent (color indication: N) only.

# Soft Fluoropolymer Tubing Metric Size **TD Series**



**Flexibility: Improved by approx. 20%**

\* SMC comparison (Fluoropolymer tubing, TL/TIL series)

## Compatible with the Food Sanitation Law

- Compatible with the test conforming to the Food Sanitation Law based on the 370th notice given by the Ministry of Health and Welfare in 1959.
- Complies with FDA (Food and Drug Administration) §177-1550 dissolution test.

## Operating Temperature: Max. 260°C

It varies depending on the operating pressure. Refer to the graph for the maximum operating pressure.

### How to measure the minimum bending radius

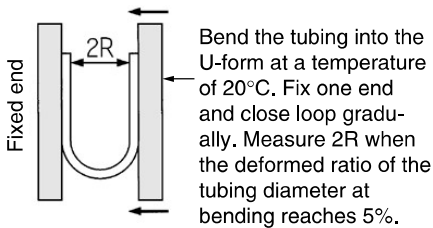

## Model/Specifications

Size		Metric size				
Model		TD0425	TD0604	TD0806	TD1075	TD1209
<b>Tubing O.D. (mm)</b>		4	6	8	10	12
<b>Tubing I.D. (mm)</b>		2.5	4	6	7.5	9
<b>Roll</b>	10 m	●	●	●	●	●
	20 m	●	●	●	●	●
<b>Color</b>		Translucent (material color)				
<b>Applicable fluid</b>		Refer to the applicable fluid in page 511.				
<b>Fluid</b> <small>Note 1)</small>		Air, Water <small>Note 1)</small> , Inert gas				
<b>Applicable fittings</b> <small>Note 2)</small>		Insert Fittings KF series Stainless Steel 316 Insert Fittings KFG series Miniature fittings M, MS series (Hose nipple type) Fluoropolymer fitting LQ series				
<b>Max. operating pressure (MPa)</b>	20°C	1.6	1.4	0.9	0.9	0.9
	100°C	0.9	0.7	0.5	0.5	0.5
	200°C	0.45	0.35	0.25	0.25	0.25
	260°C	0.23	0.2	0.15	0.15	0.15
<b>Min. bending radius (mm)</b> <small>Note 3)</small>	Recommended radius	15	25	45	55	75
	Tube close bend radius	8	16	31	35	41
<b>Max. operating temperature (fixed usage)</b>		260°C				
<b>Material</b>		Modified PTFE (Polytetrafluoroethylene resin)				

Note 1) When using a liquid fluid, the surge pressure must be under the maximum operating pressure. If the surge pressure exceeds the maximum operating pressure, it will result in damage to fittings and tubing. Furthermore, abnormal temperature rise caused by adiabatic compression may result in the tubing bursting.

Note 2) Do not use this product in a manner in which the tubing is not fixed. Observe the lesser value of the maximum operating pressure between the tubing and fittings. A material change over a long duration or due to high-temperature may cause leakage. Perform periodic maintenance and replace with a new product immediately when abnormalities are detected.

(Refer to "Maintenance" of the tubing precautions on page 514.)

For other precautions, refer to "Fittings & Tubing Precautions" on pages 13 to 17. When using the fluoropolymer fittings, refer to the precautions on pages 445 and 446.

Note 3) The minimum bending radius is the representative value measured as shown in the left figure.

- Use a tube above the recommended minimum bending radius.
- The tubing may be bent if used under the recommended minimum bending radius. Therefore, refer to the tube close bend radius and make sure that the tubing is not bent or flattened.
- Please note that the tube close bend radius is not warranted because of the value when 2R is measured by the method in the left figure if the tubing is bent or flattened, etc.

## Maximum Operating Pressure

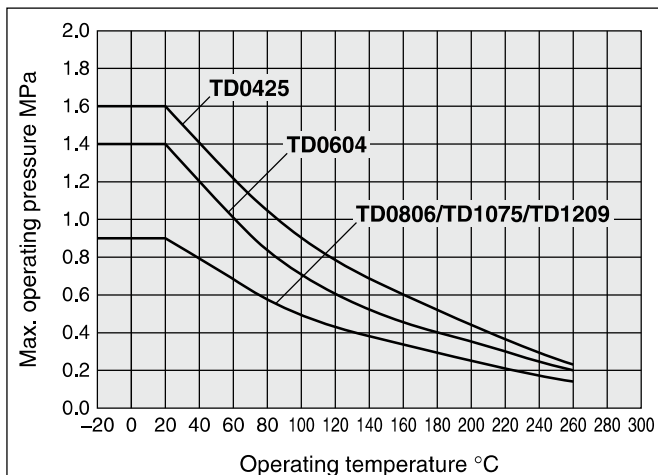

## How to Order

Metric size

**TD0425 - 10**

• Length per roll

Symbol	Length
10	10 m roll
20	20 m roll

• Tubing model

KQ2

KQB2

KS  
KX

KM

KF

M

H/DL  
L/LL

KC

KK

KK130

DM

KDM

KB

KR

KA

KQG2

KG

KFG2

MS

KKA

KP

LQ

MQR

T

IDK

# Soft Fluoropolymer Tubing Inch Size **TID Series**

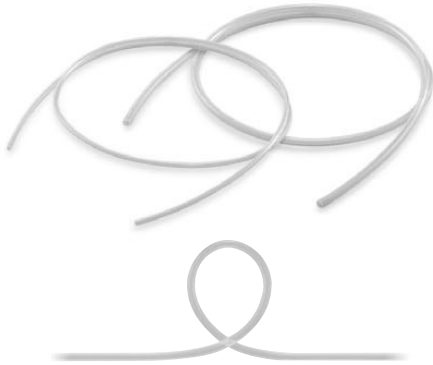

**Flexibility: Improved by approx. 20%**

\* SMC comparison (Fluoropolymer tubing, TL/TIL series)

## Compatible with the Food Sanitation Law

- Compatible with the test conforming to the Food Sanitation Law based on the 370th notice given by the Ministry of Health and Welfare in 1959.
- Complies with FDA (Food and Drug Administration) §177-1550 dissolution test.

## Operating Temperature: Max. 260°C

It varies depending on the operating pressure. Refer to the graph for the maximum operating pressure.

### How to measure the minimum bending radius

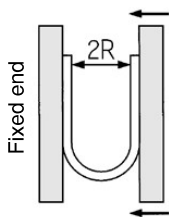

Bend the tubing into the U-form at a temperature of 20°C. Fix one end and close loop gradually. Measure 2R when the deformed ratio of the tubing diameter at bending reaches 5%.

## Model/Specifications

Size		Inch size				
Model		TID01	TID05	TID07	TID11	TID13
Tubing O.D.	inch	1/8"	3/16"	1/4"	3/8"	1/2"
	mm	3.18	4.75	6.35	9.53	12.7
Tubing I.D.	inch	0.086"	0.124" (1/8")	0.156" (5/32")	0.25" (1/4")	0.374" (3/8")
	mm	2.18	3.15	3.95	6.33	9.5
Roll	8 m (25 ft)	●	●	●	●	●
	16 m (50 ft)	●	●	●	●	●
Color	Translucent (material color)					
Applicable fluid	Refer to the applicable fluid in page 511.					
Fluid <sup>Note 1)</sup>	Air, Water <sup>Note 1)</sup> , Inert gas					
Applicable fittings <sup>Note 2)</sup>	Fluoropolymer fitting LQ series					
Max. operating pressure (MPa)	20°C	1.4	1.4	1.6	1.4	0.9
	100°C	0.7	0.7	0.9	0.7	0.5
	200°C	0.35	0.35	0.45	0.35	0.25
	260°C	0.2	0.2	0.23	0.2	0.15
Min. bending radius (mm) <sup>Note 3)</sup>	Recommended radius	15	20	25	40	75
	Tube close bend radius	9	10	15	23	42
Max. operating temperature (fixed usage)	260°C					
Material	Modified PTFE (Polytetrafluoroethylene resin)					

Note 1) When using a liquid fluid, the surge pressure must be under the maximum operating pressure. If the surge pressure exceeds the maximum operating pressure, it will result in damage to fittings and tubing. Furthermore, abnormal temperature rise caused by adiabatic compression may result in the tubing bursting.

Note 2) Do not use this product in a matter in which the tubing is not fixed.

Observe the lesser value of the maximum operating pressure between the tubing and fittings. A material change over a long duration or due to high-temperature may cause leakage. Perform periodic maintenance and replace with a new product immediately when abnormalities are detected.

(Refer to "Maintenance" of the tubing precautions on page 514.)

For other precautions, refer to "Fittings & Tubing Precautions" on pages 13 to 17. When using the fluoropolymer fittings, refer to the precautions on pages 445 and 446.

Note 3) The minimum bending radius is the representative value measured as shown in the left figure.

• Use a tube above the recommended minimum bending radius.

• The tubing may be bent if used under the recommended minimum bending radius.

Therefore, refer to the tube close bend radius and make sure that the tubing is not bent or flattened.

• Please note that the tube close bend radius is not warranted because of the value when 2R is measured by the method in the left figure if the tubing is bent or flattened, etc.

## Maximum Operating Pressure

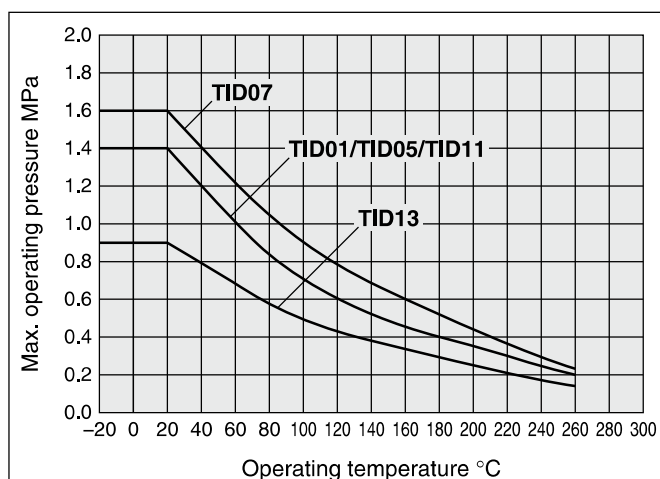

## How to Order

Inch size

**TID01 - 8**

• Length per roll

Symbol	Length
8	8 m (25 ft) roll
16	16 m (50 ft) roll

• Tubing model



## TL/TIL/TD/TID Series

# Applicable Fluid List

## Chemical resistance of Fluoropolymer Super PFA, modified PTFE material

Chemicals in the list below are chemically inert <sup>Note)</sup> to Super PFA, modified PTFE material. Possible physical effects may occur such as penetration and swelling due to temperature, pressure and chemical concentration. To use Super PFA, modified PTFE tube in a chemical environment, tests should be performed with the same environment to ensure no problem occurs with operating environment.

1,1,1-Trichloroethane	Formic acid	Trichloroethylene
1,1,2-Trichloroethane	Ethyl formate	Trichloroacetic acid
1,2,3-Trichloropropane	Propyl formate	Toluene
1,2-Dichlorobutane	Methyl formate	Naphtha
2,4-Dichlorotoluene	Xylene	Carbon dioxide
2-chloropropane	Glycol	Nitrogen dioxide
2-nitro-2-methylpropane	Glycerine	Nitrobenzene
2-nitrobutanol	Cresol	Nitromethane
Pentabasic benzamide	Chromic acid	Carbon disulfide
Hydrochlorofluorocarbon-22	Chloracetic acid	Piperidine
N-octadecanol	Chlorosulfonic acid	Pyridine
N-butylamine	Chloroform	Pyrogallol
o-chlorotoluene	Paraffinum liquidum	Phenol
Isobutyl adipate	Acetate	Butanol
Acetyl chloride	Amyl acetate	Phthalic acid
Acetophenone	Ethyl acetate	Hydrofluoric acid
Acetone	Potassium	Furan
Aniline	Butyl acetate	Ethyl propionate
Sulfurous acid gas	Propyl acetate	Propyl propionate
Allyl chloride	Methyl acetate	Methylpropionate
Benzoic acid	Salicylic acid	Propylene chloride
Ammonium	Sodium hypochlorite	Bromobenzene
Sulfur	Diisobutyl ketone	Hexachlorethane
Isoamyl alcohol	Diethylamine	Hexane
Isooctane	Carbon tetrachloride	Heptane
Ethanol	Dioxane	Benzyl alcohol
Ethyl ether	Cyclohexanone	Benzaldehyde
Ethylene glycol	Cyclohexane	Benzine
Ethylene chloride	Dichloroethylene	Benzoyl chloride
Ethylenediamine	Dichloropropylene	Benzonitrile
Zinc chloride	Dibutyl phthalate	Pentachloroethane
Aluminum chloride	Dimethyl ether	Boric acid
Ammonium chloride	Dimethylsulfoxide	Sodium boric acid
Calcium chloride	Dimethylformamide	Formaldehyde
Ferrous chloride	Hydrobromic acid	Acetic anhydride
Mercuric chloride	Potassium dichromate	Methanol
Stannous chloride	Bromine	Methyl ether
Ferric chloride	DI water (Pure water)	Methyl ethyl ketone
Cupric chloride	Nitric acid	Methylene chloride
Sodium chloride	Ammonium hydroxide	Ethyl butyrate
Magnesium chloride	Potassium hydroxide	Methyl butyrate
Hydrochloric acid	Sodium hydroxide	Hydrogen sulfide
Chlorine	Soap, detergent	Sulphuric acid
Aqua regia	Diethyl carbonate	Zinc sulfate
Ozone	Sodium carbonate	Ammonium sulfate
Oleic acid	Tetrachloroethane	Ferrous sulfate
Perchlorate	Tetrachloroethylene	Copper sulfate
Hydrogen peroxide	Tetrahydrofuran	Phosphoric acid
Natrium peroxide	Tetrabromoethane	Sodium phosphate
Gasoline	Triethanolamine	
Potassium permanganate	Triethylamine	

Note) "Chemically inert" means – not to cause any chemical reaction.

KQ2

KQB2

KS  
KX

KM

KF

M

H/DL  
L/LL

KC

KK

KK130

DM

KDM

KB

KR

KA

KQG2

KG

KFG2

MS

KKA

KP

LQ

MQR

T

IDK



# Applicable Fluid List

## Chemical resistance of Fluoropolymer PFA material

Chemicals in the list below are chemically inert <sup>(Note)</sup>, to PFA material. Possible physical effects may occur such as penetration and swelling due to temperature, pressure and chemical concentration.

To use PFA tube in a chemical environment, tests should be performed with the same environment to ensure no problem occurs with operating environment.

Acetate	Butyl stearate	Ethylene dicloride	Malic acid	Salicylic acid
Acetic anhydride	Calcium acetate	Ethylene glycol	Mercaptan	Silicate ester
Acetone	Calcium bisulfite	Ethylene oxide	Mercuric chloride	Silicone grease
Acetylene	Calcium chloride	Ethylenediamine	Mercury	Silicone oil
Acrylonitrile	Calcium hydroxide	Fatty acid	Methyl acetate	Silver nitrate
Aluminum acetate	Calcium hypochlorite	Ferric chloride	Methyl alcohol	Sodium bicarbonate
Aluminum nitrate	Calcium nitrate	Ferric nitrate	Methyl chloride	Sodium bisulfate
Aluminum bromide	Calcium sulfide	Ferric sulfate	Methyl ethyl ketone	Sodium bisulfite
Aluminum chloride	Carbon dioxide	Fluorboric acid	Methyl isobutyl ketone	Sodium hypochlorite (5%)
Aluminum fluoride	Carbon disulfide	Fluorobenzene	Methyl methacrylate	Sodium metaphosphate
Aluminum sulfate	Carbonic acid	Fluosilicic acid	Methylene dichloride	Sodium nitrate
Ammonia gas	Castor oil	Formaldehyde	Mineral oil	Sodium perborate
Ammonium carbonate	Caustic soda (30%)	Formic acid	Monochloroacetic acid	Sodium phosphate
Ammonium chloride	Cellosolve	Furfural	Monochlorobenzene	Sodium sulfite
Ammonium hydroxide	Chlorosulfonic acid	Gasoline	Monoethanolamine	Sodium thiosulfate
Ammonium nitrate	Chlorotoluene	Gelatine	Naphtha	Soybean oil
Ammonium nitrite	Chromic acid	Glauber's salt	Naphthalene	Stannic chloride
Ammonium persulfate	Citric acid	Glucose	Naphthenic acid	Stearic acid
Ammonium phosphate	Coconut oil	Glue	Natrium peroxide	Styrene
Ammonium sulfate	Copper cyanide	Glycerine	Natural gas	Sucrose solution
Amyl acetate	Copper sulfate	Grease	Nickel acetate	Sulfur
Amyl alcohol	Corn oil	Hexaldehyde	Nickel chloride	Sulfur chloride
Amyl borate	Cottonseed oil	Hexane	Nickel sulfate	Sulfuric acid (98%)
Amyl naphthalene	Creosote oil	Hexyl alcohol	Nitric acid (60%)	Sulfurous acid gas
Aniline	Cresol	Hydrobromic acid	Nitrobenzene	Tannic acid
Aniline dye	Cupric chloride	Hydrochloric acid	Nitroethane	Tartaric acid
Animal oil (Lard oil)	Cyclohexane	Hydrocyanic acid	Nitromethane	Terpineol
Aqua regia	Cyclohexanol	Hydrofluoric acid (49%)	Nitropropane	Tetrachloroethane
Arsenic acid	Cyclohexanone (Anon)	Hydrofluoric acid anhydrous	Octyl alcohol	Tetraethyl lead
Asphalt	Dibutyl phthalate	Hydrogen peroxide (30%)	Oxalic acid	Tetrahydrofuran
Barium chloride	Dichlorobenzene	Hydrogen sulfide	Oxygen	Tetralin
Barium hydroxide	Diethyl sebacate	Hydroquinone	Ozone	Thionyl chloride
Barium sulfate	Diethylene glycol	Hypochlorous acid	Palmitic acid	Triacetin
Barium sulfide	Diisopropyl keton	Isobutyl alcohol	Perchlorate	Tributoxy ethyl phosphate
Beer	Diocetyl phthalate	Isooctane	Perchloroethylene	Tributyl phosphate
Beet sugar liquors	Diocetyl sebacate	Isopropyl acetate	Petroleum	Trichloroethylene
Benzaldehyde	Dipentene (Limonene)	Isopropyl alcohol	Phenol	Tricresyl phosphate
Benzine	Diphenyl	Isopropyl ether	Phosphoric acid (75%)	Triethanolamine
Benzene (Benzol)	Diphenyl oxide	Kerosene	Picric acid	Tung oil
Benzyl alcohol	Epichlorohydrin	Lead acetate	Piperidine	Turpentine oil
Benzyl benzoate	Ethanolamine	Lead nitrate	Potassium chloride	Vegetable oil
Benzyl chloride	Ethyl acetate	Lead sulfamate	Potassium dichromate	Vinegar
Borax	Ethyl acetoacetate	Linolenic acid	Potassium hydroxide	Water
Boric acid	Ethyl acrylate	Linseed oil	Potassium nitrate	Whiskey
Bromine	Ethyl alcohol	Liquid ammonia	Potassium permanganate	Xylene
Bunker oil	Ethyl benzene	LPG (Liquefied petroleum gas)	Potassium sulfate	Zeolite
Butane	Ethyl cellulose	Lubricating oil	Propyl acetate	Zinc acetate
Butter	Ethyl chloride	Magnesium chloride	Propyl alcohol	Zinc chloride
Butyl acetate	Ethyl oxalate	Magnesium hydroxide	Propylene	Zinc sulfide
Butyl acrylate	Ethyl silicate	Magnesium sulfate	Pyridine	
Butyl alcohol (Butanol)	Ethylene chlorohydrin	Maleic acid	Pyrrrole	

Note) "Chemically inert" means – not to cause any chemical reaction.



## TH/TH Series

# Applicable Fluid List

## Chemical Resistance of Fluoropolymer FEP Material

Chemicals in the list below are chemically inert <sup>Note)</sup> to FEP material, however physical properties may be effected by temperature or pressure change.

Please make sure that operating conditions do not cause problems since the use of FEP tubing under chemical environment is unsecured.

2-nitro-2-methyl propanol	Chloroform	Nitromethane
2-nitrobutanol	Paraffinum liquidum	Perchloroethylene
Pentabasic benzamide	Allyl acetate	Perphloroxylene
N-butylamine	Ethyl acetate	Unsymmetrical dimethylhydrazine
N-octadecanol	Potassium	Hydrazine
N-butyl acetate	Butyl acetate	Pinene
O-cresol	Sodium hypochlorite	Piperidine
Di-isobutyl adipate	Carbon tetrachloride	Glacial acetic acid (Acetic acid)
Acetophenone	Dioxane	Pyridine
Acetone	Cyclohexanone	Phenol
Alniline	Cyclohexane	Phthalic acid
Abietic acid	Dimethyl ether	Dybutyl phthalate
Sulfuric chloride	Dimethylsulfoxide	Dimethyl phthalate
Isooctane	Dimethylformamide	Hydrofluoric acid
Liquid ammonia	Bromine	Naphthalene fluoride
Ethyl alcohol	DI water (Pure water)	Nitrobenzene fluoride
Ethyl ether	Nitric acid	Furan
Ethylene glycol	Mercury	Hexachlorethane
Ethylenediamine	Ammonium hydroxide	Hexane
Zinc chloride	Potassium hydroxide	Ethyl hexanoate
Aluminum chloride	Sodium hydroxide	Phenylcarbinol
Ammonium chloride	Cetane	Benzaldehyde
Calcium chloride	Soap, detergent	Benzonitrile
Sulfuric chloride	Dibutyl sebacate	Borax
Iron chloride (III)	Diethyl carbonate	Boric acid
Benzoyl chloride	Tetrachloroethylene	Formic aldehyde (Formalin)
Magnesium chloride	Tetrahydrofuran	Acrylic anhydride
Hydrochloric acid	Tetrabromoethane	Acetic anhydride
Chlorine (absolute)	Triethanolamine	Methacrylic acid
Aqua regia	Trichloroethylene	Allyl methacrylate
Ozone	Trichloroacetic acid	Vinyl methacrylate
Hydrogen peroxide	Toluene	Methyl alcohol
Natrium peroxide	Naphtha	Methyl ethyl ketone
Gasoline	Naphthalene	Methylene chloride
Permanganate	Naphthol	Sulphuric acid
Formic acid	Lead	Phosphoric acid
Xylene	Carbon dioxide	Iron phosphate (III)
Chromic acid	Nitrogen dioxide	Tri-n-butyl phosphate
Chlorosulfonic acid	Nitrobenzene	Tricresyl phosphate

Note) "Chemically inert" means – not to cause any chemical reaction.

Reference cited: Teflon®, the fluoropolymer handbook, Manual for the chemical applications of Teflon®. Du Pont-Mitsui Fluorochemicals Co., Ltd.

Teflon® is a registered trademark for the fluoropolymer produced by E.I du Pont de Nemours & Company (Inc.) and Du Pont-Mitsui Fluorochemicals Co., Ltd.

KQ2

KQB2

KS  
KX

KM

KF

M

H/DL  
L/LL

KC

KK

KK130

DM

KDM

KB

KR

KA

KQG2

KG

KFG2

MS

KKA

KP

LQ

MQR

T

IDK



# TL/TIL/TLM/TILM/TH/TH/TD/TID Series Tubing/Precautions

Be sure to read this before handling the products.

## Selection

### ⚠ Warning

#### 1. Confirm the specifications.

Products represented in this catalog are designed only for use in compressed air systems (including vacuum).

Do not operate at pressures or temperatures, etc., beyond the range of specifications, as this can cause damage or malfunction. (Refer to the specifications.)

#### 2. In case of using the product for medical care

This product is designed for use with compressed air system applications for medical care purposes. Do not use in contact with human bodily fluids, body tissues or transfer applications to a human living body.

### ⚠ Caution

#### 1. Do not use in locations where the connecting threads and tubing connection will slide or rotate.

The connecting threads and tubing connection will come apart under these conditions.

#### 2. Use tubing at or above the minimum bending radius. Using below the minimum bending radius can cause breakage or flattening of the tubing.

#### 3. Never use the tubing for anything flammable, explosive or toxic such as gas, fuel gas, or cooling mediums etc.

Because the contents may penetrate outward.

#### 4. Use the fittings applicable to the tubing size.

## Mounting

### ⚠ Caution

#### 1. Confirm model no., size, etc. before installing.

Check tubing for damage, gouges, cracks, etc.

The fluoropolymer tubing do not have the model number displayed on the product due to the resin material used. If tubing without a model label is mixed with other tubing which also does not have a model label, it is impossible to identify the model. Please avoid mixing the products with other models while it is being used and/or stored.

#### 2. When tubing is connected, consider factors such as changes in the tubing length due to pressure, and allow sufficient leeway.

#### 3. Do not apply unnecessary forces such as twisting, pulling, moment loads, etc. on fittings or tubing.

This will cause damage to fittings and will crush, burst or release tubing.

#### 4. Mount so that tubing is not damaged due to tangling and abrasion.

This can cause flattening, bursting or disconnection of tubing, etc.

## Piping

### ⚠ Caution

#### 1. Preparation before piping

Before piping is connected, it should be thoroughly blown out with air (flushing) or washed to remove chips, cutting oil and other debris from inside the pipe. Not allowing chips of the piping thread or the seal material to go in.

## Air Supply

### ⚠ Warning

#### 1. Types of fluid

This product is designed for use with compressed air.

#### 2. In case of excessive condensation

Excessive condensation in a compressed air system may cause pneumatic equipment to malfunction. Installation of an air dryer, water separator before filter is recommended.

#### 3. Drain flushing

If condensation in the drain bowl is not emptied on a regular basis, the bowl will overflow and allow the condensation to enter the compressed air lines. It causes malfunction of pneumatic devices.

If the drain bowl is difficult to check and remove, installation of a drain bowl with an auto drain option is recommended.

For compressed air quality, refer to SMC's "Air Cleaning Equipment" catalog.

## Operating Environment

### ⚠ Warning

#### 1. Do not use in locations having an explosive atmosphere.

#### 2. Do not operate in locations where vibration or impact occurs.

#### 3. In locations near heat sources, block off radiated heat.

## Maintenance

### ⚠ Caution

#### 1. Reform periodic inspections to check the following problems and replace tubing, if necessary.

- 1) Cracks, gouges, wearing, corrosion
- 2) Air leakage
- 3) Twists or crushing of tubing
- 4) Hardening, deterioration, softening of tubing

#### 2. Do not repair or patch the replaced tubing or fittings for reuse.

#### 3. When using insert or miniature fittings over a long period, some leakage may occur due to age deterioration of the materials. If any leakage is detected, correct the problem by additional tightening.

If tightening becomes ineffective, replace the fittings with a new product immediately.